



MANUAL
OPERATION



HOTEL
TRACK

FOREST CS[®] *Contract System*

Heavy duty hand drawn curtain track system for medium and heavy draperies.

THE WORLD
BEHIND
YOUR
CURTAINS



FOREST CS®



PRODUCT INFORMATION

Heavy duty hand drawn system for medium and heavy draperies
Bendable; it can be curved
Heavy duty clickable carriers - UV protected
Can be used with standard carriers or Vanda Wave Heading.
Maximum fabric weight: 15 kg per mtr
Colours available: white, black and silver
Track finish: chromated powder coating with a factory applied patented dry lubricant.
Custom cut to size - Available in various full lengths from 4.8m to 6.1m
Available with or without overlap arms

- 1 CS Track
- 2 Carrier
- 3 Master Carrier R/L Overlap
- 4 Master Carrier R/L Underlap
- 5 Endcap with screw

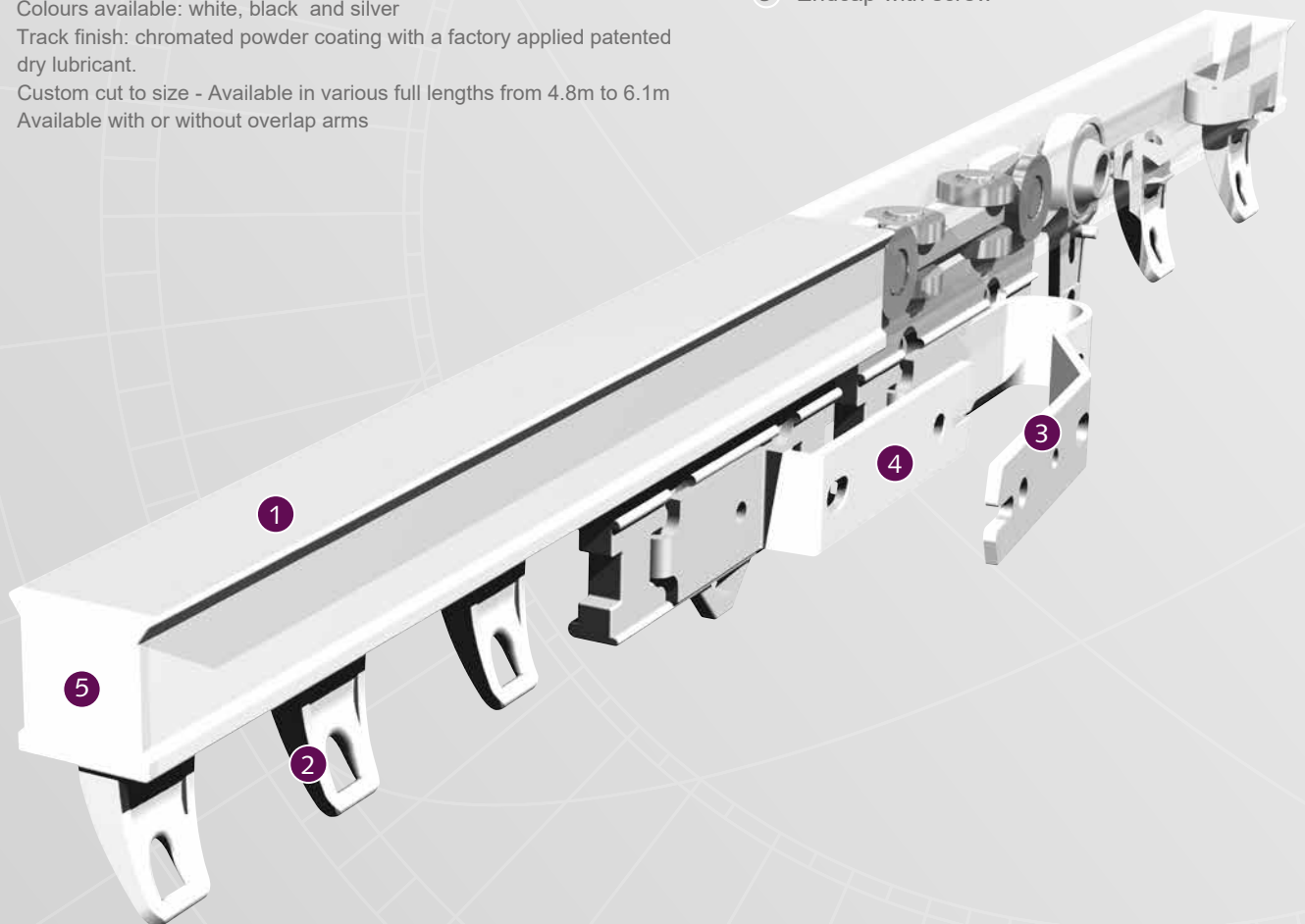



PROFILE

- Weight: 235 gram p. mtr
- Aluminium Extrusion
- Dimensions: 20 mm x 20 mm

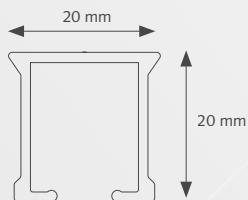

FOR USE IN

Hotels - Motels - offices - schools - healthcare residential or at any location where a heavy duty hand drawn system is required.

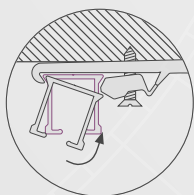

Easy installation
click - position - tighten

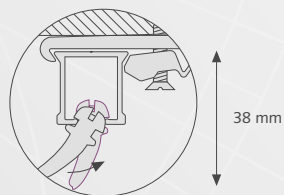

clickable carrier

BENDING / CURVING

The track can be bent and curved



APPLICATIONS

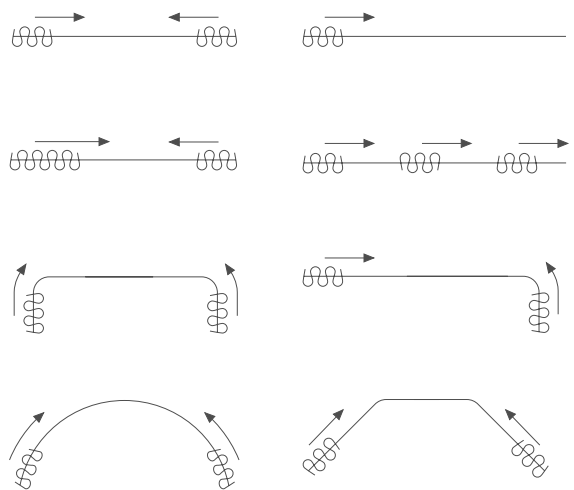

MOUNTING BRACKETS

Spring Clip Top fix bracket with Coverplate

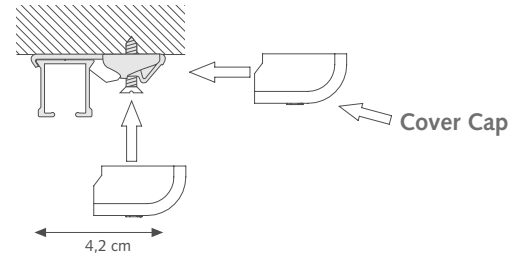

Smart Click Top Fix Bracket



SK Aluminium Wall bracket single

A) 7.5 cm B) 6.3 cm

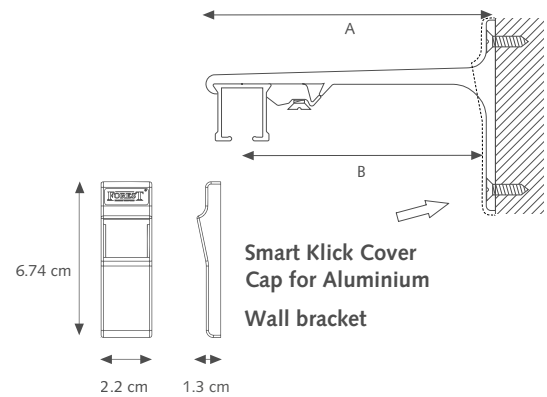

A) Min. 20 cm

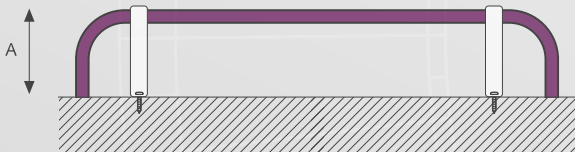

A) Min. 20 cm

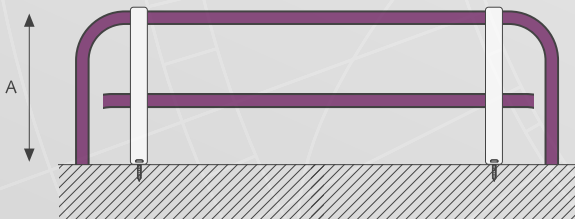

Other brackets are available. Brackets need to be placed every 60 cm (24").

SK Aluminium Wall bracket double

A) 15 cm B) 9.2 cm C) 4.5 cm

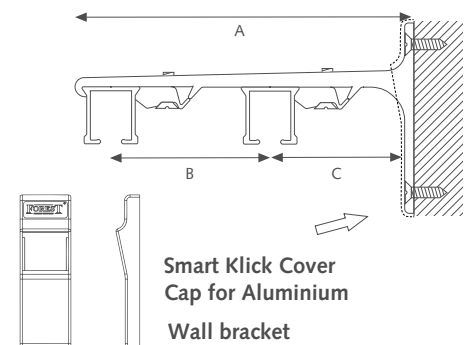

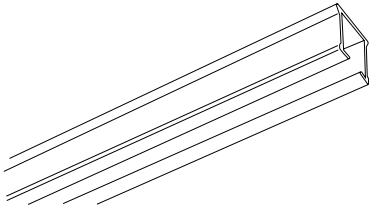

CS TRACK WHITE, SILVER, BLACK

Extruded aluminium chromated, powder coating, factory lubricated.



CS / CCS AS CARRIER

"Clickable", offset, constructed of UV-resistant plastic. 10 Carriers on a break-away strip. Can be clicked in after



CS STOPCARRIER

Clickable.



SMART CLICK TOP FIX BRACKET

Slides onto the track, powder coated. Regular duty.



SPRING CLIP TOP FIX BRACKET

"Klicks" onto track, powder coated.

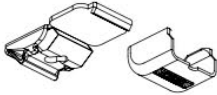

SPRING CLIP TOP FIX BRACKET WITH COVER PLATE



SMART CLICK WALL BRACKET (3.5)

"Klicks" onto track, powder coated. One screw attachment. For light weight use only.



ADJUSTABLE WALL BRACKET SINGLE

For light weight use only

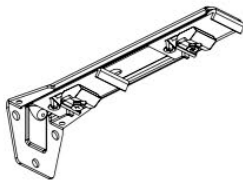

ADJUSTABLE WALL BRACKET DOUBLE

For light weight use only



SLIMLINE SINGLE WALL BRACKET

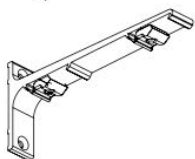

SLIMLINE DOUBLE WALL BRACKET



COVERPLATE FOR

WALL BRACKET

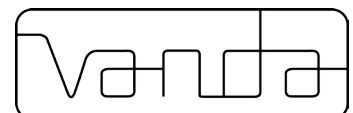

0800 826 326

Enquiries@vanda.co.nz